

Part no.

410 K F 01 F D N A3 B X D X
 1 2 3 4 5 6 7 8 9 10 11 12

- | | |
|--|---|
| 1.SERIES NO.
410=Fakra | 10.1=RG174
2=RTK031 |
| 2.K=Crimp Terminal Type | 11.PACKING STYLE:
D=BAG |
| 3.GREEN OPTION:
F=RoHS (Matte) | 12.INSULATOR COLOR:
A=Black
B=White
C=Blue
D=Bordeaux
E=Green
F=Brown
G=Grey
H=Violet
I=Beige
K=Curry
L=Carmine Red
M=Pastel Orange
N=Pastel Green
Z=Water Blue |
| 4.CONTACT NUMBER:
01=1 PINS
A1=1 PINS (COXOC Logo) | |
| 5.CONTACT TYPE:
F=FEMALE | |
| 6.CONTACT AREA PLATING:
D=30u" GOLD | |
| 7.SOLDER TAILS AREA PLATING:
N=50u"~150u" Nickel | |
| 8.APPLY TYPE:
A3=Straight | |
| 9.SHELL PLATING:
B=Plastic | |

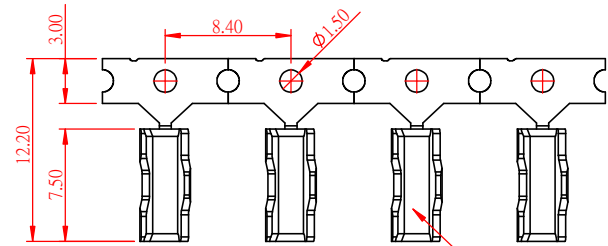
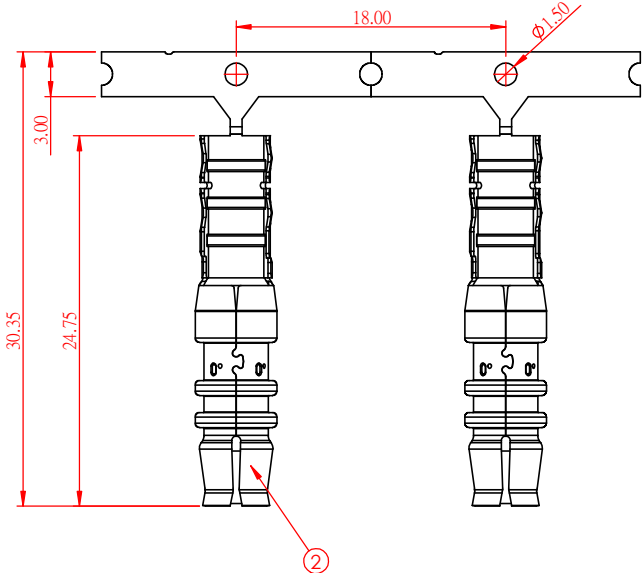
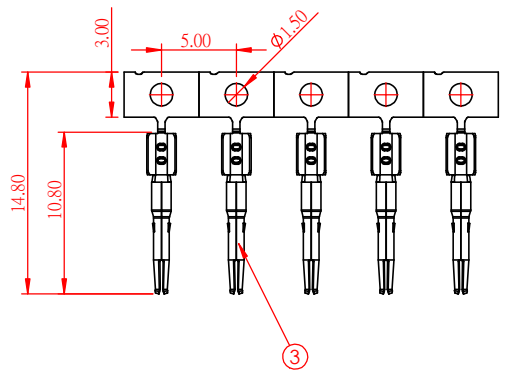
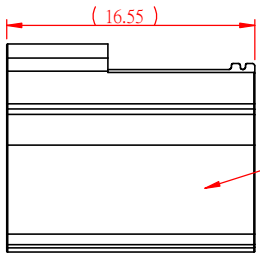
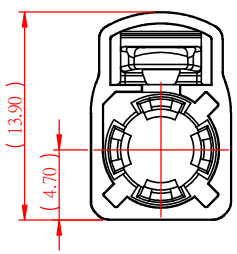

For RG174

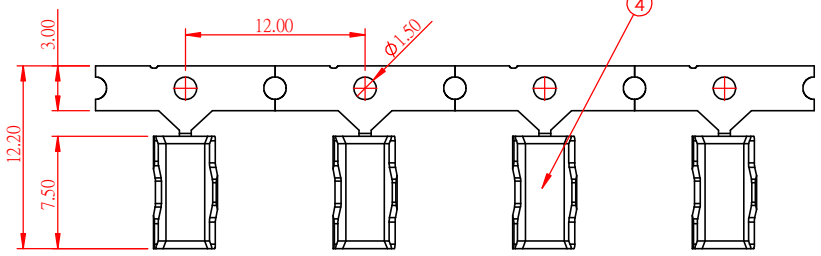

For RTK 031

MATERIALS AND FINISHES

Item	Part Name	Part Number	Material	Finishes	Qty
1	Coding Housing	M1410KEX1FA3X02A	PBT	See Table	1
2	Shell Sub- Assembly	S410KF01FTTA3XC1	PBT & Phospor Bronze	60u"~120u" Tin	1
2-1	Inner Housing				
2-2	Spring				
3	Center Contact	M2410KEKDNA30XA	Corrosion Copper	Contact Area: 30u" Gold Solder Area: 50u"~150u" Tin	1
4	Cable Clip	M4410KF25TA300XA	Brass	60u"~120u" Tin	1

UNLESS OTHERWISE SPECIFIED TOLERANCE	
ANG.	±5°
0.	±0.50
.0	±0.30
.00	±0.20



CHANT SINCERE CO.,LTD
 TEL:886-02-86471251 FAX:886-02-86472962

SCALE: AS SHOWN	UNIT: mm
DRAWN JERRY	05/13/20
CHECKED	/ /
APPROVED	/ /

DRAWN NAME:	FAKRA Straight Jack 1/3
PRODUCT NO.	410KFX1FDNA3BXDX
FILE NAME:	C-410KFX1FDNA3BXDX

X5		05/13/20
REV.	DESCRIPTION	DATE



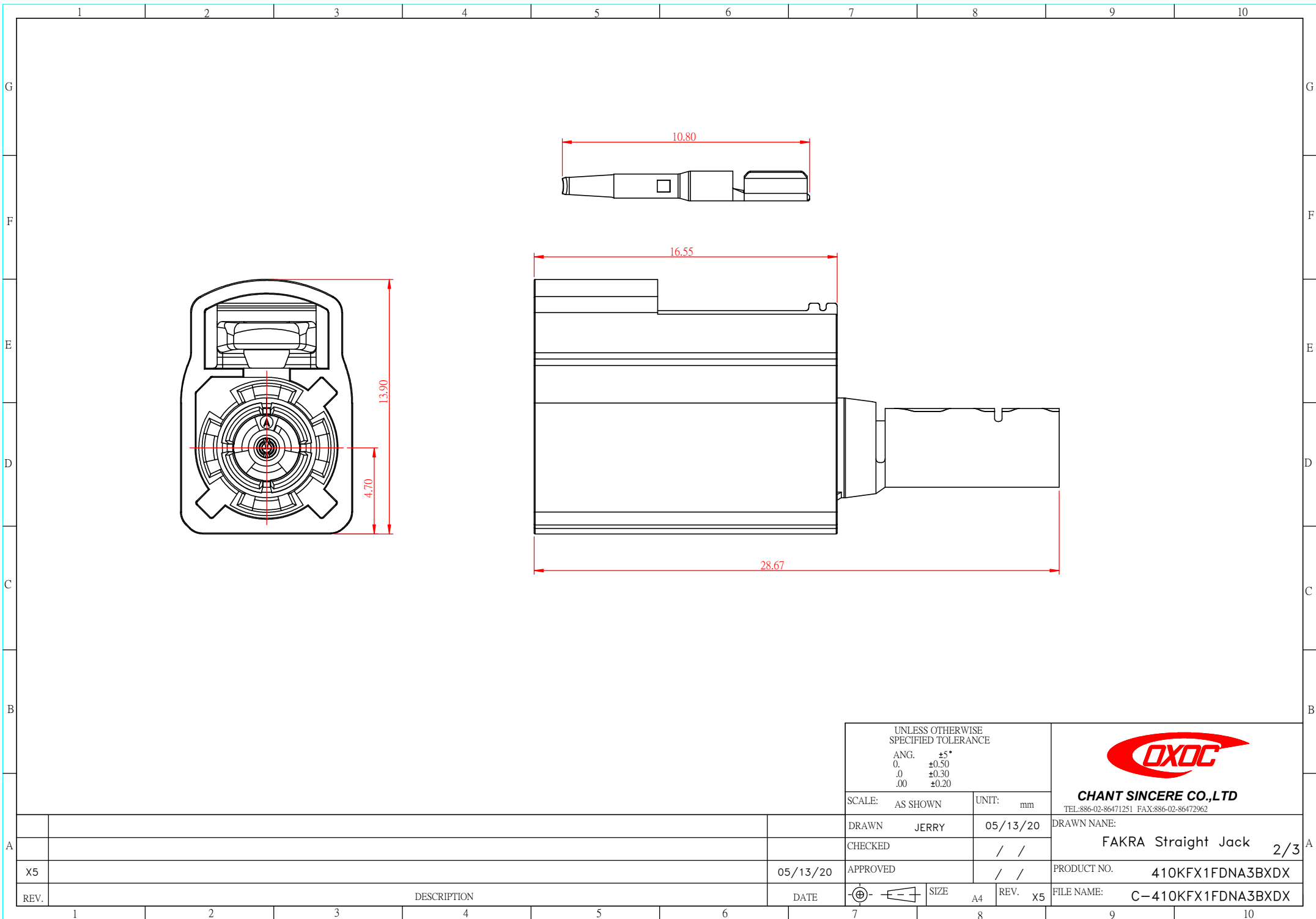

UNLESS OTHERWISE SPECIFIED TOLERANCE
 ANG. $\pm 5^\circ$
 0. ± 0.50
 .0 ± 0.30
 .00 ± 0.20

SCALE: AS SHOWN UNIT: mm



CHANT SINCERE CO.,LTD
 TEL:886-02-86471251 FAX:886-02-86472962

DRAWN JERRY 05/13/20

DRAWN NAME:
FAKRA Straight Jack 2/3

CHECKED / /

APPROVED / /



PRODUCT NO. **410KFX1FDNA3BXDX**

DATE 05/13/20

SIZE A4 REV. X5

FILE NAME: **C-410KFX1FDNA3BXDX**

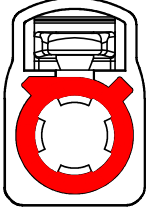
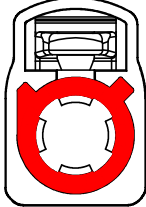
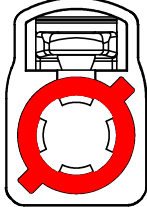
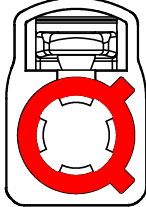
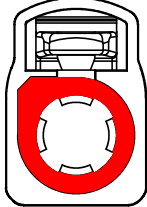
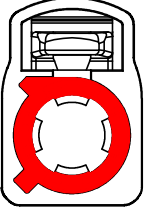
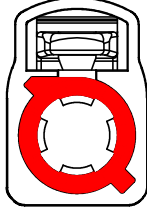
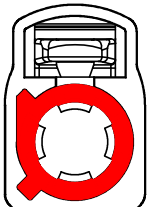
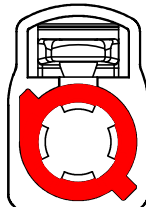
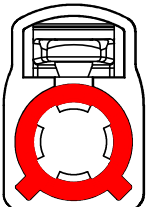
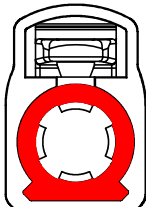
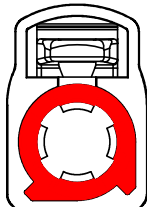
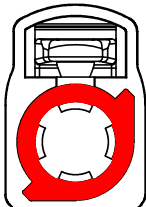
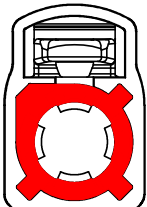
REV.	DESCRIPTION	DATE
X5		05/13/20

	1	2	3	4	5	6	7	8	9	10
	Codings 1:1									
G	Coding	A	B	C	D	E	F	G		
F	Plug									
	Color	Black	White	Blue	Bordeaux Violet	Green	Brown	Grey		
	RAL	sim.9005	sim.9001	sim.5005	sim.4004	sim.6002	sim.8011	sim.7031		
E	Coding	H	I	K	L	M	N	Z		
D	Plug									
	Color	Violet	Beige	Curry	Camine Red	Pastel Orange	Pastel Green	Water Blue		
C	RAL	sim.4003	sim.1001	sim.1027	sim.3002	sim.2003	sim.6019	sim.5021		
B										
						UNLESS OTHERWISE SPECIFIED TOLERANCE ANG. $\pm 5^\circ$ 0. ± 0.50 .0 ± 0.30 .00 ± 0.20		 CHANT SINCERE CO.,LTD <small>TEL:886-02-86471251 FAX:886-02-86472962</small>		
A						SCALE: AS SHOWN	UNIT: mm	DRAWN NAME: FAKRA Straight Jack 3/3		
						DRAWN JERRY	05/13/20	PRODUCT NO. 410KFX1FDNA3BXDX		
X5						CHECKED	/ /	FILE NAME: C-410KFX1FDNA3BXDX		
REV.	DESCRIPTION					DATE	APPROVED	/ /		
	1	2	3	4	5	6	7	8	9	10