

RECOMMENDED P.C.B. LAYOUT
TOLERANCE : $\pm 0.02\text{mm}$

SPECIFICATION
MATERIAL:
 Insulator: LCP E130i
 Contacts: Brass C2680
 Shell: Zamak3
CONTACT PLATING:
 Contact area: 6u" Selective Gold
 Solder tails area: 50u"~150u" Tin(Matte)
ELECTRICAL:
 Impedance: 50Ω
 Insulator Resistance: 1000MΩ Min. at 100V DC
 Withstanding Voltage: AC 800Vrms Min. 60Hz
 Voltage Rating: AC 335Vrms
 Current Rating: 1.0A Max.
 Contact Resistance: 10mΩ Max. at 20mV Max.
 Operation Temp. Range: -40 degree to +105 degree
 Mating Cycles: 25 insertions

Part no. 410 D F 01 N 6 T A4 T X C X
 1 2 3 4 5 6 7 8 9 10 11 12

- 1.SERIES NO.
410=Fakra Series
- 2.D=SMT Type
- 3.GREEN OPTION:
F=RoHS (Matte Plated)
- 4.CONTACT NUMBER:
01=1 PINS
- 5.CONTACT TYPE:
N=MALE
- 6.CONTACT AREA PLATING:
6=6u" GOLD
- 7.SOLDER TAILS AREA PLATING:
T=50u"~150u" Tin(Matte)
- 8.APPLY TYPE:
A4=Mid Mount
- 9.SHELL PLATING:
T=120u"~240u" Tin(Matte)
- 10.Corpling nose direction:
2=up
3=down
4=Left
5=Right
- 11.PACKING STYLE:
C=TAPE REEL
- 12.INSULATOR COLOR:
A=Black
B=White
C=Blue
D=Boardeaux
E=Green
F=Brown
G=Grey
H=Violet
I=Beige
K=Curry
L=Carmine Red
M=Pastel Orange
N=Pastel Green
Z=Water Blue

UNLESS OTHERWISE SPECIFIED TOLERANCE	
ANG.	$\pm 5^\circ$
0.	± 0.50
.0	± 0.30
.00	± 0.20
SCALE: AS SHOWN	UNIT: mm

CHANT SINCERE CO.,LTD
 TEL:886-02-86471251 FAX:886-02-86472962

E9	X4	Added Coding Nose Direction	31/08/2020	DRAWN Bill_hsu	31/08/2020	Title: Fakra R/A Plug for PCB with Housing (Mid Mount) 1/3 Part NO. 410DF01N6TA4TXCX Factory: GC Customer:
F3	X3		05/05/2020	CHECKED Jerry_Chou	01/09/2020	
	X2		14/04/2020	APPROVED Mark	01/09/2020	
Zone	Revision	Description	Date	SIZE A4	REV. X4	

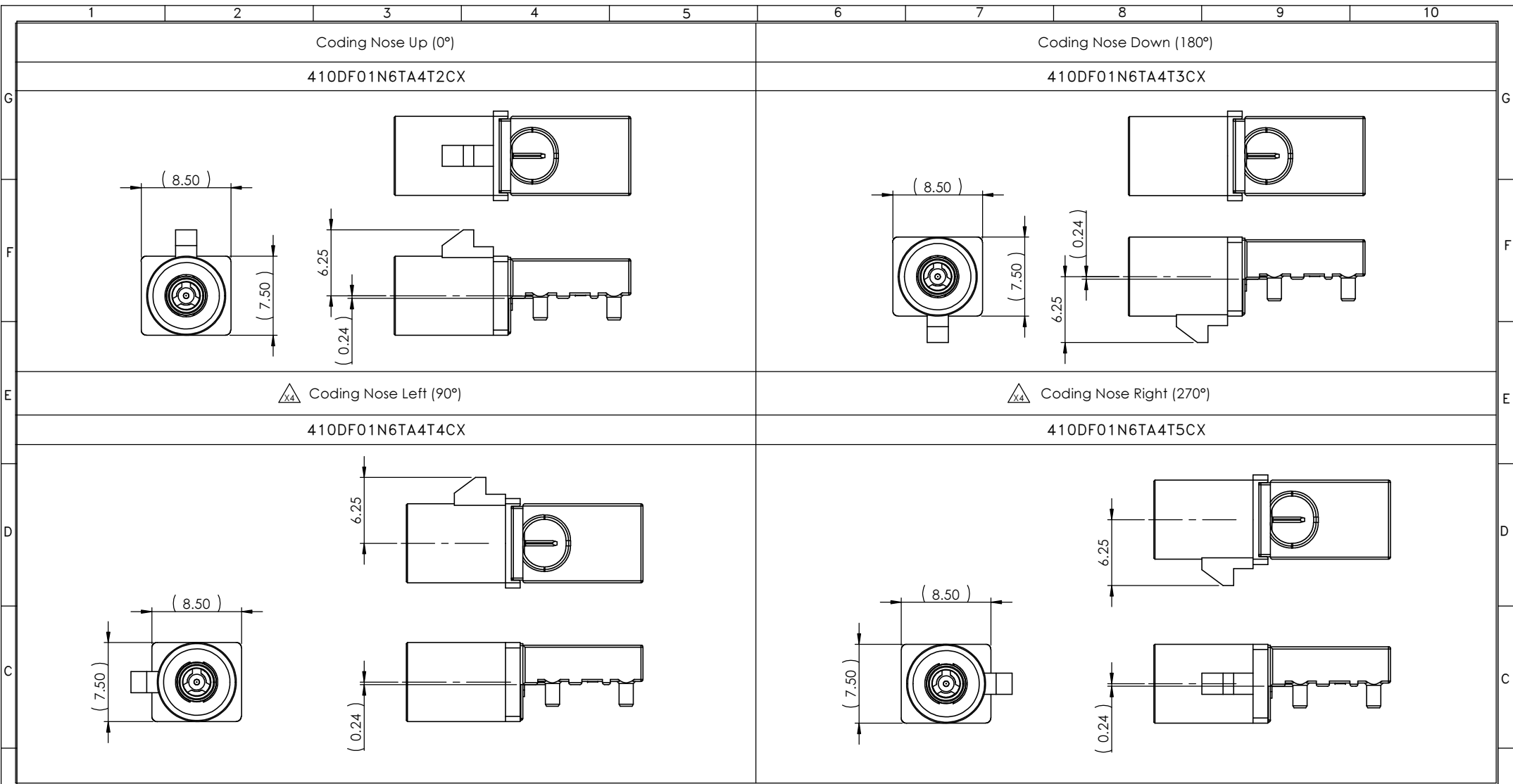

					UNLESS OTHERWISE SPECIFIED TOLERANCE ANG. ±5° 0. ±0.50 .0 ±0.30 .00 ±0.20				
					SCALE: AS SHOWN		UNIT: mm		
E7, E3		X4		Added Coding Nose Direction		31/08/2020		DRAWN Bill_hsu 31/08/2020	
		X3		See Page 1		05/05/2020		CHECKED Jerry_Chou 01/09/2020	
		X2				14/04/2020		APPROVED Mark 01/09/2020	
Zone		Revision		Description		Date		Part NO. 410DF01N6TA4TXXC Factory: GC Customer:	
1	2	3	4	5	6	7	8	9	10

CHANT SINCERE CO.,LTD
 TEL:886-02-86471251 FAX:886-02-86472962
 Title: Fakra R/A Plug for PCB with Housing (Mid Mount) 2/3

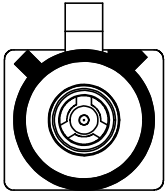
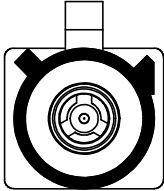
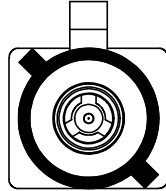
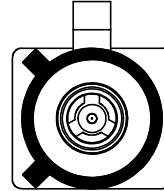
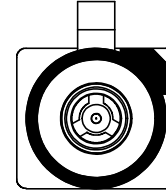
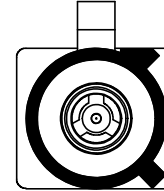
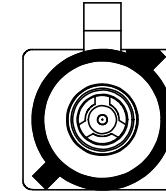
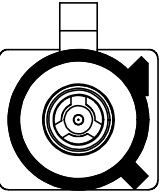
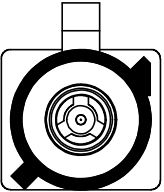
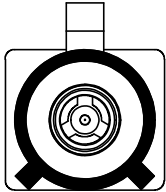
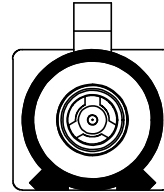
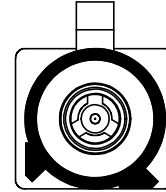
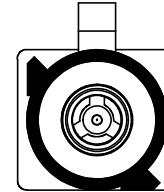
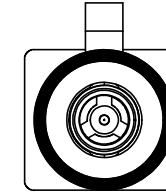
Codings 1 : 1							
Coding	A	B	C	D	E	F	G
Plug							
Color	Black	White	Blue	Bordeaux Violet	Green	Brown	Gray
RAL	sim.9005	sim.9001	sim.5005	sim.4004	sim.6002	sim.8011	sim.7031
Coding	H	I	K	L	M	N	Z
Plug							
Color	Violet	Beige	Curry	Camine Red	Pastel Orange	Pastel Green	Water Blue
RAL	sim.4003	sim.1001	sim.1027	sim.3002	sim.2003	sim.6019	sim.5021

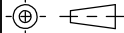
					UNLESS OTHERWISE SPECIFIED TOLERANCE ANG. ±5° 0. ±0.50 .0 ±0.30 .00 ±0.20		 CHANT SINCERE CO.,LTD TEL:886-02-86471251 FAX:886-02-86472962	
		See Page 2 & 3		31/08/2020	DRAWN Bill_hsu	31/08/2020	Title: Fakra R/A Plug for PCB with Housing (Mid Mount) 3/3 Part NO. 410DF01N6TA4TXCX Factory: GC Customer:	
		See Page 1		05/05/2020	CHECKED Jerry_Chou	01/09/2020		
				14/04/2020	APPROVED Mark	01/09/2020		
Zone	Revision	Description			Date	 SIZE A4	REV. X4	